

# Radio Remote Controls Manual

## Series C1 / C2

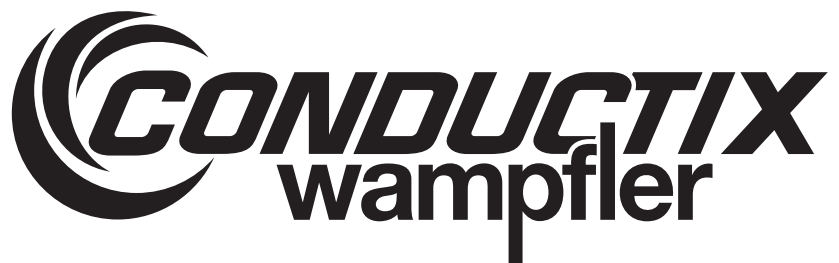

# Conductix Incorporated

The technical data and images which appear in this manual are for informational purposes only. **NO WARRANTIES, EXPRESS OR IMPLIED, INCLUDING WARRANTIES OF MERCHANTABILITY OR FITNESS FOR A PARTICULAR PURPOSE, ARE CREATED BY THE DESCRIPTIONS AND DEPICTIONS OF THE PRODUCTS SHOWN IN THIS MANUAL.** Conductix makes no warranty (and assumes no liability) as to function of equipment or operation of systems built according to customer design or of the ability of any of its products to interface, operate or function with any portions of customer systems not provided by Conductix.

Seller agrees to repair or exchange the goods sold hereunder necessitated by reason of defective workmanship and material discovered and reported to Seller within one year after shipment of such goods to Buyer.

Except where the nature of the defect is such that it is appropriate, in Seller's judgment, to effect repairs on site, Seller's obligation hereunder to remedy defects shall be limited to repairing or replacing (at Seller's option) FOB point of original shipment by Seller, any part returned to Seller at the risk and cost of Buyer. Defective parts replaced by Seller shall become the property of Seller.

Seller shall only be obligated to make such repair or replacement if the goods have been used by Buyer only in service recommended by Seller and altered only as authorized by Seller. Seller is not responsible for defects which arise from improper installation, neglect, or improper use or from normal wear and tear.

Additionally, Seller's obligation shall be limited by the manufacturer's warranty (and is not further warranted by Seller) for all parts procured from others according to published data, specifications or performance information not designed by or for Seller.

Seller further agrees to replace or at Seller's option to provide a refund of the sales price of any goods that do not conform to applicable specifications or which differ from that agreed to be supplied which non-conformity is discovered and forthwith reported to Seller within thirty (30) days after shipment to the Buyer. Seller's obligation to replace or refund the purchase price for non-conforming goods shall arise once Buyer returns such goods FOB point of original shipment by Seller at the risk and cost of Buyer. Goods replaced by Seller shall become the property of Seller.

There is no guarantee or warranty as to anything made or sold by Seller, or any services performed, except as to title and freedom from encumbrances and, except as herein expressly stated and particularly, and without limiting the foregoing, **there is no guarantee or warranty, express or implied, of merchantability or of fitness for any particular purpose or against claim of infringement or the like.**

Seller makes no warranty (and assumes no liability) as to function of equipment or operation of systems built to Buyer's design or of the ability of any goods to interface, operate or function with any portions of Buyer's system not provided by Seller.

Seller's liability on any claim, whether in contract, tort (including negligence), or otherwise, for any loss or damage arising out of, connected with, or resulting from the manufacture, sale, delivery, resale, repair, replacement or use of any products or services shall in no case exceed the price paid for the product or services or any part thereof which give rise to the claim. In no event shall Seller be liable for consequential, special, incidental or other damages, nor shall Seller be liable in respect of personal injury or damage to property not the subject matter hereof unless attributable to gross misconduct of Seller, which shall mean an act or omission by Seller demonstrating reckless disregard of the foreseeable consequences thereof.

Seller is not responsible for incorrect choice of models or where products are used in excess of their rated and recommended capacities and design functions or under abnormal conditions. Seller assumes no liability for loss of time, damage or injuries to property or persons resulting from the use of Seller's products. Buyer shall hold Seller harmless from all liability, claims, suits and expenses in connection with loss or damage resulting from operation of products or utilization of services, respectively, of Seller and shall defend any suit or action which might arise there from in Buyer's name - provided that Seller shall have the right to elect to defend any such suit or action for the account of Buyer. The foregoing shall be the exclusive remedies of the Buyer and all persons and entities claiming through the Buyer.

## 1.0 Radio Warranty

- 1.1 Warranty
- 1.2 Warranty Period
- 1.3 Warranty Service
- 1.4 Excluded Parts
- 1.5 Remarks

## 2.0 Safety Considerations

- 2.1 Symbols
- 2.2 Warnings

## 3.0 Standard Components

- 3.1 Receiver (RX)
- 3.2 Transmitter (TX)
- 3.3 Accessories
  - 3.3.1 Per Radio Kit
  - 3.3.2 Per Radio Transmitter

## 4.0 Installation Procedure

- 4.1 General Procedure
- 4.2 Receiver Setup
  - 4.2.1 Installation Preparation
    - 4.2.1.1 Modify Power Supply Connection
  - 4.2.2 Installation Procedure
    - 4.2.2.1 Radio Schematics
- 4.3 Transmitter Setup
  - 4.3.1 Procedure

## 5.0 Operation

- 5.1 General Precautions
- 5.2 Standard Operation
  - 5.2.1 Power On Procedure
  - 5.2.2 TX Power Indication
  - 5.2.3 Operational Frequency
    - 5.2.3.1 Check Procedure
    - 5.2.3.2 Change Procedure
- 5.3 Programming
  - 5.3.1 Via Radio (TX->RX)
    - 5.3.1.1 Channel Procedure
    - 5.3.1.2 Function Procedure
  - 5.3.2 Via Copier
- 5.4 Emergency Procedure

## 6.0 Basic Troubleshooting and Maintenance

- 6.1 General Precautions
- 6.2 General Error Code and Resolution
- 6.3 Detailed RX Codes and Resolution
- 6.4 Detailed TX Codes and Resolution

## 7.0 Function Settings

- 7.1 Pushbutton Customization
- 7.2 R1/R2 Settings
- 7.3 Operational Power-On Modes
- 7.4 Password Operation

## 8.0 Function Settings

- 8.1 General
- 8.2 Transmitter
- 8.3 Receiver

## 9.0 Appendix

- 9.1 General Wiring Diagram  
(for Radio/Pendant Operation)

# 1.0 Radio Warranty

## 1.1 Warranty

Conductix-Wampfler guarantees that this equipment meets its published specifications at the time of shipment from the factory. This equipment will perform as described if installed properly. However, Conductix-Wampfler cannot guarantee that operation of remote control system is absolutely error-free, or without interruption.

## 1.2 Warranty Period

This equipment is warranted against defects in materials and workmanship for a period of two (2) years from the date of shipment. During the warranty period, Conductix-Wampfler's is responsible for necessary repairs/replacement as long as the product can be proven defective.

## 1.3 Warranty Service

For warranty service or repair, this equipment must be returned to Conductix-Wampfler. Customer is responsible for shipping charges to Conductix-Wampfler. Conductix-Wampfler's warranty covers only parts and factory labor. No on-site in and out charges are covered under this warranty.

## 1.4 Excluded Parts

This warranty does not include consumable parts such as joysticks, batteries, fuses, buttons, and relays. Also, this warranty does not cover defects caused by improper installation, improper/insufficient maintenance, unauthorized modification, improper operation, ignorance of environmental specifications, and/or improper software/interfaces.

## 1.5 Remarks

No other warranty is expressed or implied, except for the above mentioned. The remedies provided herein are the buyers' sole and exclusive remedies. Conductix-Wampfler shall not be liable for any direct/indirect, special, incidental, or consequential damage. Consult Conductix-Wampfler general warranty for further information.

# 2.0 Safety Considerations

## 2.1 Symbols

### Safety Considerations

This product and related documentation must be reviewed for familiarization with safety markings and instructions before operation. This product requires strict adherence to instructions in order to ensure operational safety.

### Safety Symbols

The following symbols may be found on the remote control or throughout the remote control documentation. Their purpose is to alert you to potentially dangerous situations.



#### Refer To Manual

When the product is marked with this symbol refer to the instruction manual for additional information.



#### High Voltage

Indicates presence of hazardous voltage. Unsafe practice could result in severe personal injury.



#### Protective Earth Ground

Indicates protective earth terminal



#### Warning

Denotes hazard. Included text will give proper instructions. Failure to follow instructions could result in severe personal injury and/or property damage.



#### Caution

Denotes hazard. Included text will give proper instructions. Failure to follow instructions could result in minor personal injury and/or property damage.

## 2.0 Safety Considerations

### 2.2 Warnings



1. Read this manual carefully before operating and installing this product.

2. Due to the complex nature of equipment, it is necessary to read the entire manual before installation.

3. Only authorized personnel should service this equipment. Unauthorized work on this unit will void the warranty.



4. This manual is for reference only; please call your distributor or Conductix-Wampfler if further assistance is required.

5. The equipment has been tested for correct operation before delivery from the factory. However, it must not be used in critical or hazardous operation where incorrect operation may cause personal or equipment damage.

6. After daily operation, please shut off main power in crane, the power to the receiver, and remove transmitter key.

7. Transmitter should be placed in a safe place when not in use to avoid accidental pressing of buttons.



8. The crane should be equipped with mainline contactor, limit switches, and other require safety devices as dictated by CMAA, OSHA, or all other applicable governing regulations.

9. The GND (ground) of receiver must be connected to ground of machine, or electrical shock can occur.

10. Do not use this device during electrical storms or under conditions of electrical interference.



11. Ensure transmitter batteries are in good condition and power for receiver is correct.

12. Installation and maintenance should be done only while the machine's main power and receiver's power are off and locked out to prevent electrical shock.

13. Contents of the manual may be amended by the manufacturer without notice.

## 3.0 Standard Components

A standard and full set of C1/C2 wireless pendant consists of:

700SHHC1 and 700SHHC2 Kits include a single (1) transmitter

700DHHC1 and 700DHHC2 Kits include two (2) transmitters.

**NOTE:** Upon receipt of the radio kit, please identify and verify the following components are included as listed.

### 3.1 Receiver



C1 Receiver Part Number = 701C0008

C2 Receiver Part Number = 701C0017

### 3.2 Transmitter



C1, Single Speed Transmitter, Part Number = 701C0009

C2, Two Speed Transmitter, Part Number = 701C0018

## 3.0 Standard Components

### 3.3.1 Accessories Per Radio Kit

1. 701C0031 - IOM (Installation and Operations Manual - C1/C2 Series) (1 pc.)
2. 701C0024 - Spare Key (1 pc.)
3. Spare Fuse Kit
4. Radio Setting Sheets

### 3.3.2 Accessories Per Radio Transmitter

1. 700DIROP10 - Alkaline batteries for transmitter (4 pcs.)
2. 701C0026 - Strap for transmitter (1 pc.)
3. 701C0025 - Button legend sheet for transmitter (1 pc.)
4. 701C0041 - Protective Cover (1 pc.)

## 4.0 Installation Procedures

### 4.1 General Precautions



1. Observe all safety precautions when climbing or working on the machine.
2. Turn off the main power source of cranes before installation to avoid electric shock. Lockout/Tagout the main power source.
3. Receiver must be installed as to not touch any part of the machine or structure during the operation, except for mounting provisions.
4. The receiver must be fastened securely via shock-proof mount provided.
5. Before installation, inspect the crane's safety devices and make sure everything is in proper working condition.
6. Make sure you understand the crane circuits and power distribution as well as the function setting of this remote controller, to avoid incorrect wiring.



7. To avoid any interference, the receiver must be located away from motors, frequency drives, and power cables (shown below).
8. **Coil suppressors must be installed on all contractor coil and relay coils. Conductix-Wampfler recommends RC type suppressors Conductix-Wampfler Parts 103KVFCC1 with wire leads or 103KVFCC2 with bare metal leads.**
9. The receiver should be installed on the exterior surface of the electrical control box. Mounting the receiver inside the electrical control box is not correct, An external antenna kit (Conductix-Wampfler part number 700DIROP9) must be used when receiver is installed in a metal enclosure.

### 4.2 Receiver Preparation

#### 4.2.1 Preparation

1. Read through the following steps and procure all proper tools to complete this installation.
2. Select a proper location.
  - a. Select a stable place free from electrical noise, vibration, excessive heat, etc.
  - b. Select a place where you can see the receiver or antenna from the ground.
  - c. Select a place where there is no interference (e.g. keep away from motors, relays, magnetic switch, and power cables).
  - d. Keep away from high voltage wiring and devices.

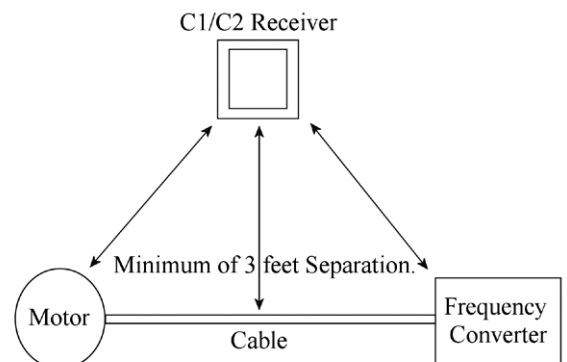

## 4.0 Installation Procedures

### 4.2.1 Preparation (continued)

e. The Receiver's box must be at least 1.5" (4cm) away from the other obstacles.

#### 3. Receiver Power Supply

The input power source for the receiver can be 110VAC, 220VAC, or 380 VAC 50/60Hz (for 2VDC please contact Conductix-Wampfler). **Measure your supply voltage, it must be within 10% of the selected above nominal voltages, failure to do so will void the warranty.**

**NOTE: The Factory Default is 110VAC**

#### 4.2.1.1 Modify Power Supply Connection

After the desired power supply is confirmed disconnect the plug from the 110V connector, located in the lower left corner of the relay module board as shown, and insert it into the correct connector on the relay module. Verify the plug is inserted correctly.

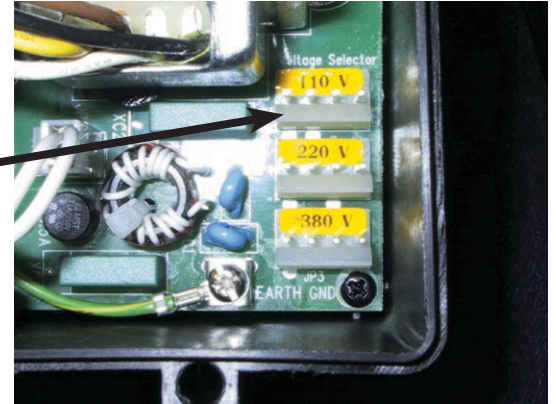

### 4.2.2 Installation Procedure

1. Turn off the main power for crane or device.
2. Find a proper place for the receiver as detailed in the previous section.
3. Drill a hole for the 8mm stud, mount the receiver with 8mm diameter hex nut.
4. Connect wires to the control circuit of crane according to the receiver's wiring diagram and control contact diagram.
5. Secure the cables between the receiver and crane so that the cable sheath will not wear out due to vibration of the crane.
6. Open the top cover of the receiver and turn the relay module's Run/Test switch to "Test" position. The toggle switch is located in the upper left of the relay board as shown:
7. Turn on the main power for crane.
8. Complete Section 4.3 and then operate the transmitter to test every function and make sure all motions are correct (read by LED indicator).  
**NOTE:** When the Run/Test switch is set to "Test" position, relay will not function, but the LED indicator will light.
9. Turn Run/Test switch to "Run" position and secure the top cover to the receiver with screws.  
**CAUTION: When securing the cover be careful not to pinch any wires between the case and the lid.**
10. This completes the installation of receiver.

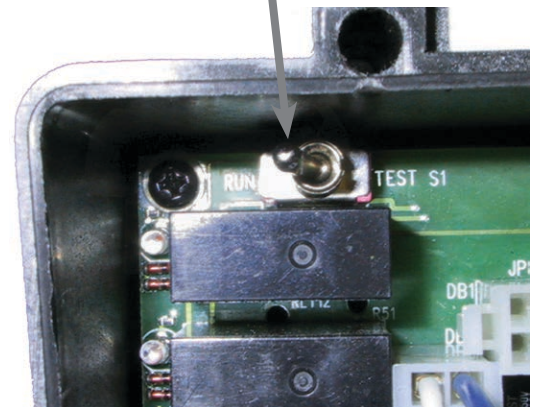

# 4.0 Installation Procedures

## 4.2.2.1 Radio Schematics

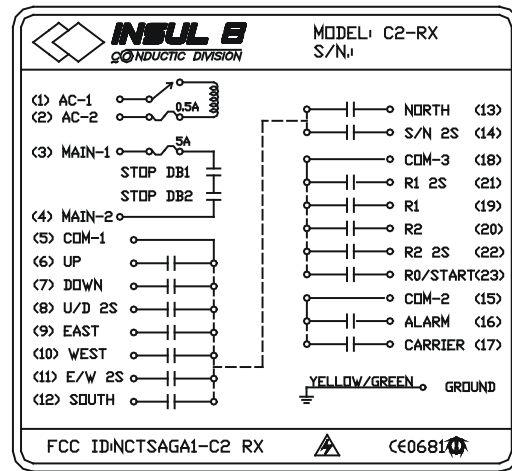
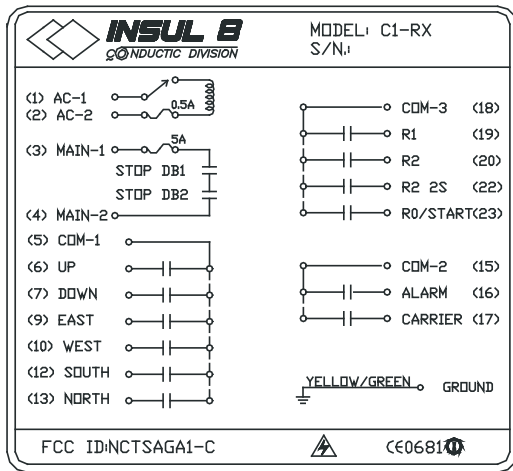

**NOTE:** It is necessary to provide proper external fusing on all required commons in accordance with the relay's power handling to avoid damage to the receiver and voiding of the warranty.



Wires 15, 16 & 17 are NOT Encoded E/O. They are intended for light and alarm signals only NOT motor function.

## 4.3 Transmitter Setup

### 4.3.1 Procedure

Place batteries in proper direction into battery compartment, and screw on transmitter's bottom cover, after battery installation the transmitter will sound two (2) 0.5 second long beeps to indicate proper installation.



**NOTE:** For the following procedures the buttons on the transmitter will be referred to as noted above.



## 5.0 Operation

### 5.1 General Precautions



1. After operating, please press EMS (Emergency Mushroom Stop) mushroom to shut off main power in the receiver remove transmitter key.
  2. Stop operating when irregular response occurs due to insufficient transmitter power, beyond the remote control range, or severe interference.
  3. Remove the batteries when the equipment is not going to be used for a long period of time.
  4. Operators must be properly trained and certified, understanding safe operation of the machine and this radio control.
  5. Operator must be familiar with emergency procedures before operating (See Section 5.4).
- 
6. Transmitter is durable and weather-resistant, but care should be taken not to subject it to severe impacts or undue abuse.
  7. This product is suitable for use in industrial environments. Proper care and maintenance will extend system's life.
  8. Check EMS mushroom and the other security functions of entire system before daily operation, including (but not limited to) switches, E-Stop operation, etc.
  9. Stop operating if the operator's view is not clear of machine or load.
  10. Press EMS mushroom when malfunctions or abnormal conditions occur.

### 5.2 Operation

#### 5.2.1 Default Power On Procedure

1. Rotate EMS mushroom clockwise and pull out.
2. Turn rotary key switch clockwise to "ON" position.
3. Continue to turn key switch to "START" position in order to turn on power (after releasing the rotary key switch, it will automatically return to the "ON" position).

#### 5.2.2 Transmitter Power Indication

Transmitter has power indication function with LED display.

"Green Color" Sufficient power to operate transmitter (In order to save power, one can Program to turn off LED display when power level is sufficient).

"Yellow Color" Power is depleting, warning sound occurs every four (4) seconds (sound intervals can be set by software). Operation must be stopped immediately (for example, lower the hoist, remove load) to replace batteries.

"Red Color" Insufficient Power. In addition to red LED, warning sound will continue and transmitter is no longer functional. Transmitter will send out an emergency stop signal to the receiver due to insufficient power. Operator should avoid this situation in order to maintain operation safely.

#### 5.2.3 Operational Frequency

This remote controller provides three (3) operating frequencies. When the remote controller is interfered by radio waves and will not operate properly, the operator can change the transmitter's frequency according to the following procedure without changing the channel in the receiver. This eliminates the trouble accessing the receiver directly.

Operation Frequency Band	LED Color	Corresponding Pushbutton
Frequency Band A	Red	#1 pushbutton
Frequency Band B	Yellow	#2 pushbutton
Frequency Band C	Green	#3 pushbutton

## 5.0 Operation

### 5.2.3.1 Frequency Band Check Procedure

Step	Procedure
1	Press the EMS mushroom
2	Turn the rotary key to "OFF" position
3	Turn key clockwise from "OFF" position. At this moment the LED on the transmitter will display a color corresponding to a frequency as shown in the table in section 5.2.3

Step	Procedure
1	<b>Press the EMS mushroom</b>
2	<b>Turn the rotary key to "OFF" position</b>
3	Depress and hold the pushbutton in accordance with the desired frequency band as noted in Section 5.2.3. <b>NOTE:</b> The pushbutton must be depressed and held until step 6 is complete.
4	Turn key clockwise from "OFF" to "ON" position.
5	Once the LED has ceased flashing turn security key counter-clockwise from "ON" to "OFF" position.
6	Complete. Release button
7	Power-On according to the proper procedure described previously and return to normal operation.

### 5.2.3.2 Frequency Band Change Procedure

## 5.3 Programming

You can only complete radio remote setting if the transmitter has been setup for remote setting at the factory.

### 5.3.1 Via Radio (Transmitter -->Receiver)

This procedure refers to the process of the transmitter's remote writing of the function software into the receiver. Store the required setting in transmitter in advance then send out the radio signal to receiver to program. This performance can eliminate the trouble of accessing the receiver. Radio remote settings include: "Channel Setting and "Function Settings."

#### NOTES:

1. Before operating, make sure that all out put relays are in "OFF" status (i.e. the receiver is in "Power-Off" mode).
2. Before operating, make sure that the communication status between transmitter and receiver is in good condition.

## 5.0 Operation

### 5.3.1.1 Channel Procedure

Step	Procedure
1	Depress EMS mushroom and turn the rotary key to "OFF" position.
2	Depress and hold "#3" and "#4" pushbuttons and turn key from "OFF" to "ON" position simultaneously.
3	Release "#3" and "#4" pushbuttons. At this time, LED indicator will flash with yellow and green color alternately.
4	After the alarm of receiver sounds one long tone "-" (one long tone means that channel setting is completed), turn the rotary key from the "ON" to "OFF" position.
5	After the alarm of receiver sounds one long tone "-" (one long tone means that channel setting is completed), turn the rotary key from the "ON" to "OFF" position.

### 5.3.1.2 Function Procedure

Step	Procedure
1	Depress EMS mushroom and turn the rotary key to "OFF" position.
2	Depress and hold "#3" and "#4" pushbuttons and turn key from "OFF" to "ON" position simultaneously.
3	Release "#3" and "#4" pushbuttons. At this time, LED indicator will flash with yellow and green color alternately.
4	After the alarm of receiver sounds one long tone "-" (one long tone means that channel setting is completed), turn the rotary key from the "ON" to "OFF" position.
5	After the alarm of receiver sounds one long tone "-" (one long tone means that channel setting is completed), turn the rotary key from the "ON" to "OFF" position.

### 5.3.2 Via Copier

The copier (Conductix-Wampfler Part Number 700DIROP3) instructions are detailed in a separate manual. Please contact Conductix-Wampfler for information.

### 5.4 Emergency Procedure

1. Press EMS Mushroom.
2. Turn the rotary key to the "OFF" position.
3. Remove the rotary key.
4. Open the battery compartment and remove the transmitter's batteries.
5. Shut off the main power of the crane and discontinue operation until the problem is resolved.
6. Contact your distributor or Conductix-Wampfler to diagnose the problem.

## 6.0 Basic Troubleshooting

### 6.1 General Precautions

Daily inspection is important and will ensure safety of operation. Inspection should include testing “emergency stop” and other safety devices and functions. If there is any doubt, operation must be stopped immediately and problems must be corrected before operation is resumed.

**NOTES:**

1. Malfunction alarm mode can be set by software for the “Simple Alarm Mode.” Simple Alarm Mode is discussed in section 6.2. The following Sections 6.3 and 6.4 explain the “Morse Mode” for error messages.
2. Alarm (error messages) are transmitted according to Morse Code. “-” indicates short tone for duration of 0.25 of a second; “-” indicates a long tone for a duration of 0.5 of a second; intervals between tones are 0.25 of a second. An example for a transmitter pushbutton error message follows.
3. When an error message is detected by receiver or transmitter’s self-diagnostics, an alarm will sound and “Power-OFF” will be activated. Unless the malfunction has been corrected, it will be impossible to “Power-ON” the radio system.
4. Maintenance technicians can use these error messages. However, we recommend the technician replace only the module. The defective module should be returned to the distributor for the repair of components. This will eliminate further damage to the radio control.
5. If you do not understand an error message from the transmitter or receiver, or the signal is not listed in this manual, please contact Conductix-Wampfler for clarification and recommendations.

### 6.2 General Error Code and Resolutions

In order to simplify maintenance, this remote control system has been designed with the built-in self-diagnostics circuits in the transmitter and receiver. As long as the CPU is in proper working condition, malfunctions in pushbutton, RF circuit, relay, and relay driver circuits (including relay coil and relay contact) can be detected. When malfunction occurs, transmitter or receiver will generate a simple and clear alarm. Not only will the operator and maintenance personnel fully understand the condition of remote controller, but the self-diagnostics can also reduce lost production time by signaling the cause of damage.

**NOTE:** When “Simple Alarm Mode” is selected, alarm signals are shown on the list below. When “Morse Alarm Mode” is selected, please refer to

Malfunction	Error Message	Simple Alarm Signal	NOTE
Transmitter	Encoder Module Malfunction	-	Each “-” indicates a 0.5 second alarm. Each pause between lasts 0.25 seconds. The alarm message will repeat every (2) seconds
	RF Module Malfunction	- -	
	Insufficient Power to Operate the Transmitter	- - -	
Receiver	Relay Module Malfunction	-	
	Receiver / Decoder Module Malfunction	- -	
	Power Failure	- - -	

sections 6.3 and 6.4.

## 6.0 Basic Troubleshooting

### 6.3 Detailed Receiver Codes and Resolutions

NOTES:

Item	Morse Code	Descriptions	Correction
1	● -	#1 "UP" relay coil damage	Contact Conductix-Wampfler to Repair/Replace Relay Module.
2	- ● ● ●	"U/D 2S" relay coil damage	
3	- ● - ●	#2 "DOWN" relay coil damage	
4	- ● ●	#3 "EAST" relay coil damage	
5	●	"E/W 2S" relay coil damage	
6	● ● - ●	#4 "WEST" relay coil damage	
7	- - ●	#5 "SOUTH" relay coil damage	
8	● ● ● ●	"S/N 2S" relay coil damage	
9	● ●	#6 "NORTH" relay coil damage	
10	● - - ●	"MAIN" relay coil damage	
11	- - ● -	Relay contact is jammed (cannot open) on COM1	
12	● - ●	The input voltage supply is beyond tolerance	1. Turn off the main power 2. Verify the voltage select plug is at the correct position 3. Inspect and confirm the power is normal before resuming operation
13	● ● ●	RF Circuit Malfunction	Replace "Receiver/Decoder" Module.
14	- ● - -	Interfered by the same model of remote controller	Change to a new frequency
15	● - - - -	Interfered by another radio on the same frequency	If interference is not serious, turn off and "Power-On"
16	- - ● ●	E <sup>2</sup> PROM in the Receiver / Decoder does not have a complete program setting	Contact Conductix-Wampfler for installation of new setting.

- When receiver's self-diagnostics detects a malfunction, alarm will continue, unless the malfunction has been corrected or the power to the receiver has been disconnected.
- Items 14 and 15 can be configured to not alarm via software.
- The receiver can be set by software to close the relative action (i.e. "Relay-Off") or "Power-Off" automatically, when the error occurs relating to items 14 and 15. In the other items, the receiver will enter into the Auto Power Off Mode.
- This receiver contains an Auto Gain Control circuit with high sensitivity; when not in operation, it may receive weak signal from unknown sources. As long as the interference does not occur very often, it will not affect the normal operation. No frequency change is necessary.

## 6.0 Basic Troubleshooting

### 6.4 Detailed Transmitter Codes and Resolutions

When a transmitter cannot function properly and there is no alarm information, please follow the procedures below to identify the malfunction and its resolution.

Item	Malfunction	Actions Required
1	Transmitters LED and buzzer do not react at all.	<ol style="list-style-type: none"> <li>1. Ensure battery power is normal               <ol style="list-style-type: none"> <li>a. Check direction of batteries</li> <li>b. Check condition of batteries</li> </ol> </li> <li>2. Make sure CPU is normal               <ol style="list-style-type: none"> <li>a. Press EMS mushroom and turn key to "OFF" position.</li> <li>b. Remove battery cover and remove the transmitter's batteries.</li> <li>c. Put batteries into battery compartment and replace battery cover. At this time, battery should generate two long tones. Otherwise, the CPU is out of order or the battery connection wires are abnormal.</li> </ol> </li> <li>3. Check program of receiver and transmitter if modified from factory settings.</li> <li>4. Return for repair.</li> </ol>
2	Transmitter is normal, but receiver's buzzer does not react at all.	<ol style="list-style-type: none"> <li>1. Ensure the receiver's power source is normal:               <ol style="list-style-type: none"> <li>a. Inspect "Receiver/Decoder" to see if the Squelch indicating light is on</li> <li>b. Inspect AC power fuse and DC power fuse to see if the fuse is burnt out. If necessary, turn off the main power and replace the fuse.</li> </ol> </li> <li>2. Ensure the "Receiver/Decoder" Module and "Relay" Module are wired correctly.</li> <li>3. Ensure the output fuse of the relay is not burnt out. Replace fuse if necessary.</li> <li>4. Ensure the alarm's relay is not out of order (if the alarm's LED is on, it means the relay is out of order).</li> <li>5. Check programming of receiver and transmitter if modified from factory settings.</li> <li>6. Return for repair.</li> </ol>
3	A certain motion does not work.	<ol style="list-style-type: none"> <li>1. Ensure the output fuse of the relay is not burnt out. Replace fuse if necessary.</li> <li>2. Ensure the original control system of crane works properly. If not, consult the crane or machine manufacturer.</li> <li>3. Check programming of receiver and transmitter if modified from factory settings.</li> <li>4. Return for repair.</li> </ol>

## 6.0 Basic Troubleshooting

### NOTES:

1. If the malfunction of pushbutton has occurred the buzzer will sound and the LED indicator will flash with red color simultaneously when the power is reset (e.g. change of battery). During operation the transmitter will perform self-diagnostics when EMS mushroom is pressed. If the malfunction of item 3 is occurred, only LED indicator (flash with red color) will indicate the error message when you press the EMS mushroom.

2. The alarm for other items will sound only when you push the pushbuttons or when the power source is reset (e.g. change of battery). If the transmitter is functional yet a malfunction has been detected, it will produce the following morse code values:

Item	Morse Code	Descriptions	Correction
1	- ● - ●	Malfunction of E <sup>2</sup> PROM memory	Replace encoder module
2	- ● ●	E <sup>2</sup> PROM in the encoder is not fully programmed	Requires re-programming; Consult factory
3	● ● - ●	Malfunction of pushbutton; Shorted contacts	Replace encoder module
4	● - ●	Batteries are dead	Replace Batteries
5	● ● ●	RF module malfunction	Replace RF module

## 7.0 Function Settings

### 7.1 Pushbutton Customization

The C1/C2 radio series pushbuttons can be programmatically altered at the factory to operate in a variety of modes.

1. Normal Momentary Operation
2. On/Off Mode - This mode allows the button pair to operate a single relay turning on and off with a pair of buttons.
3. Toggle Mode - This mode allows each button to be alternated between an open and closed state maintaining that state until pressed again.

## 7.0 Function Settings

### 7.2 R1/R2 Settings

The R1/R2 buttons located bottom row of transmitter (position #7 & #8) can also be programmed to operate in the following modes in addition to in standard momentary and toggle modes detailed in Section 7.1

1. **Bypass EMS:** When in Toggle (maintained mode) this allows the R1/R2 pair to ignore the emergency stop and retain its current state. Such operation is desired when an operation must be maintained even in the case of emergency such as with a claw or magnet.
2. **Acceleration/Deceleration Mode:** The R1/R2 pair can close their associated relays in sequence and maintain their state until the deceleration button is pressed or the motion button is released. Please contact Conductix-Wampfler for application information.
3. **Inching Mode:** Pressing the R1 button will cause the contact to close for a specified amount of time and then release. This time can be set from 0.1 to 0.5 seconds in increments of 0.1 seconds.
4. **Interlocked Mode Settings:** By default the R1/R2 buttons are configured in a interlocked mode. To change them to non-interlocked a jumper must be placed to connect the two (2) pins located just above the transformer as shown above.

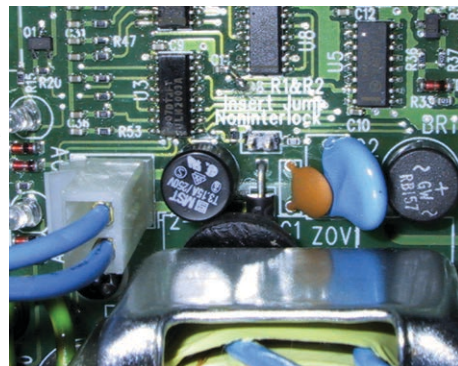

As the above picture shows, if R1/R2 pushbutton requires non-interlocked operation, then the shorting header must be placed on the the 2 pins located just above the transformer.

#### NOTES:

1. The jumper is provided and attached to the upper lid of the receiver. If your jumper is missing, please contact Conductix-Wampfler for a replacement.
2. When R1/R2 is set up as a non-interlocked toggle pair, the output is from wires 19 and 22 respectively.

### 7.3 Optional Power On Modes

These additional methods of powering can be set at the factory. If you have requested one of the following optional modes, use the steps below to turn our your radio system.

1. Any Pushbutton Power-On Mode
  - a. Rotate EMS mushroom clockwise and pull out.
  - b. Turn rotary key switch clockwise on "ON" position.
  - c. Press any pushbutton on the transmitter. This will turn on the power as well as arm the transmitter and execute the function of the depressed pushbutton.
2. European Union (E.U.) Standard Power-On Mode
  - a. Rotate EMS mushroom clockwise and pull out.
  - b. Turn rotary key switch clockwise to "ON" position.
  - c. Continue to tun of key switch to "START" position to turn on power (after release rotary key switch, it will automatically return back to "ON" position).
  - d. After three (3) minutes of non-operation, transmitter will send out an emergency stop signal to the receiver. When this occurs, turn rotary key switch counter-clockwise to the "OFF" position. Then turn the key clockwise to the "ON" position, and continue to turn key switch to "START" position to turn on the power.

**NOTE:** When setting is on "E.U. Standard Power-On," the transmitter is in the "continuous" mode.

#### 3. Software Power-On Mode:

This Power-On Mode is controlled by the software. It consists of:

- a. Whether the receiver will "Power-Off" automatically when not operating for an extended time period.
- b. Whether a password is required to turn on power.
- c. Whether an emergency stop signal will be sent out.



## 7.0 Function Settings

### 7.4 Password Operation

1. Rotate EMS mushroom clockwise and pull out.
2. Turn key clockwise to "ON" position.
3. Press the pushbutton sequentially to enter password within 10 seconds (Remark: This time duration of "Password Enter" can be set by software. At the time of "Password Enter" the LED indicator will flash with green color).
4. The buzzer of the transmitter will sound one-long beep sound to indicate the password is correct. After buzzer turns off, "Power-On" according to the proper procedure and return to normal operation.
5. If password is incorrect, then the buzzer will sound with two (2) short beeps and one (1) long beep. Enter the correct password again after buzzer has turned off.

#### NOTES:

1. The function of the password can be set by the software in order to avoid unauthorized people from using the remote.
2. One must re-enter password to return to normal operation if EMS mushroom has been pressed (or "emergency stop" signal has been transmitted due to transmitter auto power off).
3. Turning key switch to "OFF" and back to "ON" will not require re-entry of password.

## 8.0 Specifications

### 8.1 General

Operating Frequency	410 ~ 490 MHz (Default 433 to 435 MHz)
Hamming Distance	$\geq 4$
I.D. Code	2 <sup>32</sup> ; more than 4 billion codes (set by factory, never repeated)
Temperature Range	-22°F ~ 167°F (-30° ~ +75°C)
Channel Spacing	5kHz/6.25kHz or itegral multiple (12.5 kHz Default)
Maximum Operation Range	Up to 330 ft. (100 meters)
Structure	Glass Fiber-Nylon
Protection Degree	IP65 (NEMA 4)

### 8.2 Transmitter

Power Supply	Four 1.5 volt Alkaline or rechargeable batteries (AA size)
RF Power	< 10 mWatts
Modulation	$\pm 2.5$ kHz; Narrow Band FM
Pushbutton Type	One or two-step Mechanical Switch
Dimensions	6.42" x 1.93" x 1.77" (163 x 49 x 45 mm) (L x W x H)
Weight	0.62 lbs. (280 g.) (w/batteries)

### 8.3 Receiver

Power Supply	AC 115/220/380V (50/60Hz) (tolerance $\pm 10\%$ ) selectable DC 12V (tolerance $\pm 10\%$ )
Sensitivity	-110 DBm (Date Error Rate $<10^{-3}$ )
Image Rejection	> 60 dB
Adjacent Channel Rejection	>80 dB ( $\pm 20$ kHz)
Output Relays	10A/250VAC; 8A/30VDC
Dimensions	6.57" x 6.06" x 3.46" (167 x 154 x 88 mm) (L x W x H)
Weight	3.08 lbs. (1400 g.) (w/o cable)

# 9.0 Appendix

## 9.1 General Wiring Diagram (for Radio/Pendant Operation)

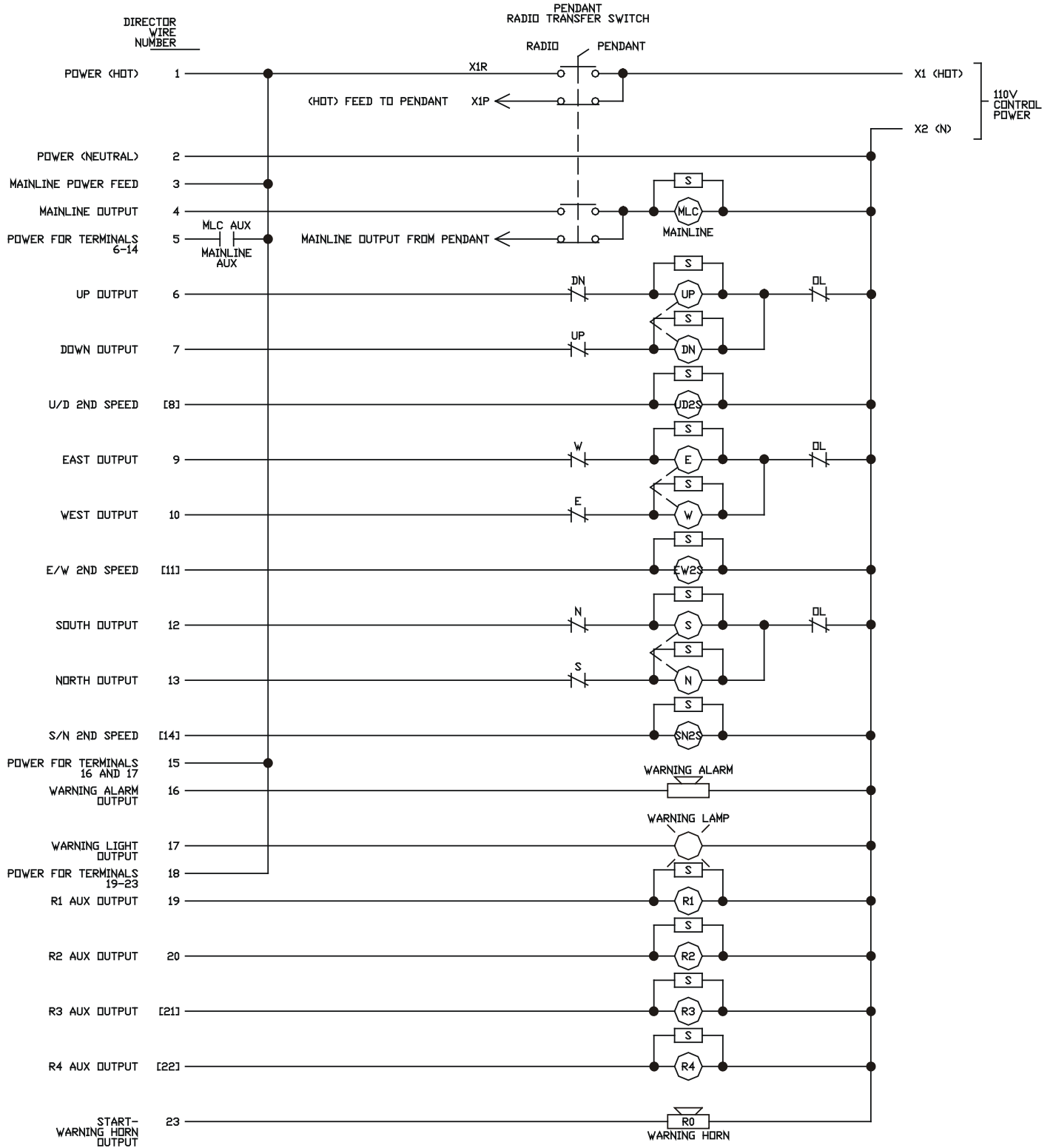

NOTES:

[ ] = OUTPUTS AVAILABLE ON C2 MODELS ONLY

— S — SUPPRESSORS MUST BE INSTALLED ON ALL COILS

ONLY FOR REFERENCE.  
ACTUAL FIELD WIRING WILL DIFFER FROM SYSTEM TO SYSTEM

INSULATE ALL UNUSED WIRES

## Notes

# www.conductix.us

## USA / LATIN AMERICA

10102 F Street  
Omaha, NE 68127

Customer Support  
Phone +1-800-521-4888

Phone +1-402-339-9300  
Fax +1-402-339-9627

info.us@conductix.com  
latinamerica@conductix.com

## CANADA

1435 Norjohn Court  
Unit 5  
Burlington, ON L7L 0E6

Customer Support  
Phone +1-800-667-2487

info.ca@conductix.com

## MÉXICO

Calle Treviño 983-C  
Zona Centro  
Apodaca, NL México 66600

Customer Support  
Phone (+52 81) 1090 9519  
(+52 81) 1090 9025  
(+52 81) 1090 9013

Fax (+52 81) 1090 9014

info.mx@conductix.com

## BRAZIL

Rua Dois, 493  
Itu, São Paulo, Brasil  
CEP: 13312-820

Customer Support  
Phone (+55 11) 4813 7330

Fax (+55 11) 4813 7330

info.br@conductix.com

Contact us for our Global Sales Offices

