

# Product Overview **Besta** Power Compressed Air and Electric Supply



**CONDUCTIX**  
wampfler







# Solutions from a Single Source



**Solutions** are born as ideas and implemented through **products**.

Conductix-Wampfler's handling systems can be found in many industries. Our compressed air and electric supply systems provide solutions to build ergonomic workplaces.

Conductix-Wampfler develops customized system solutions to meet your requirements. Customers from many industries trust Conductix-Wampfler products.

Robust, high-quality products make on-site installation simple. Low maintenance and repair costs save time and money over the system's lifetime.

As a system supplier, we offer our customers complete service, not just the delivery of the products themselves – including steelwork and the lighting if desired. Competent consulting, planning of the entire project, selection and procurement of components and accessories, appropriate logistics design, and on-site commissioning make Conductix-Wampfler stand out.

The result is that critical data and required power are safely, reliably, and permanently available wherever and whenever they are needed.

Anywhere in the world!

You can count on it!



Easy packaging:  
**C40 with Festoon System**  
in a shipping warehouse



Fully integrated:  
**A62 on an assembly line**

# System Structure

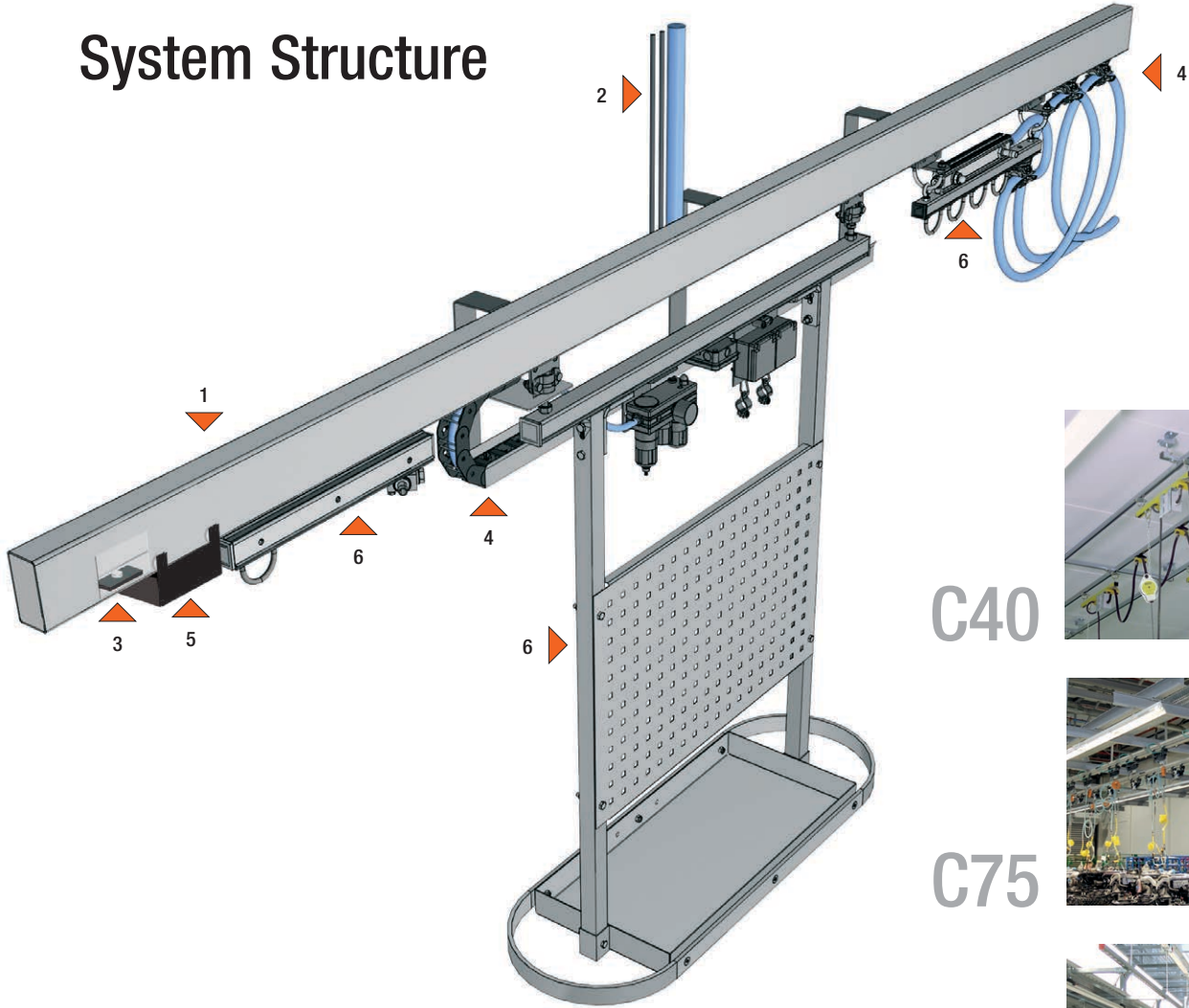

- 1. Track
- 2. Power feed (electrical power, compressed air, etc.)
- 3. Tapping valve
- 4. Mobile power supply (electrical power, compressed air, etc.)
- 5. Tapping carriage
- 6. Equipment carrier



C40

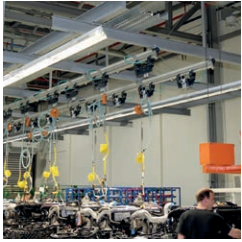

C75



A62

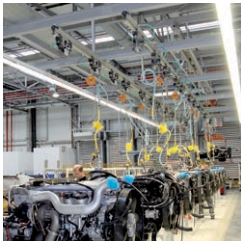















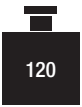
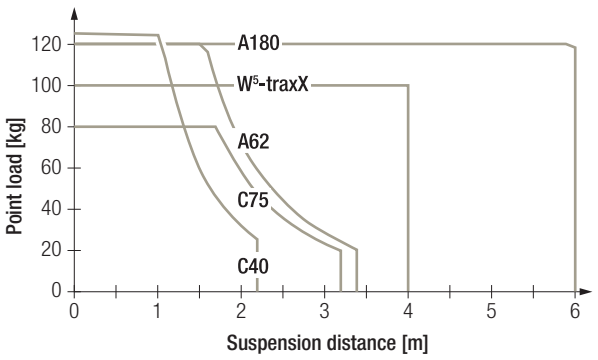















W<sup>5</sup>-traxX



A180

# Overview of Program

Bestapower custom media supply: From simple festoon systems to integrated compressed air aluminum profiles with tapping valve.

	C40	C75	A62	W <sup>5</sup> -traxX	A180	
Page	7	9	11	13	15	
<b>Loads and distances</b>						
Max. load capacity [kg] at 2 m standard suspension distance	 40	 65	 80	 100	 120	
						
Suspension distance max.	◀ 2.2 m ▶	◀ 3.2 m ▶	◀ 3.4 m ▶	◀ 4 m ▶	◀ 6 m ▶	
Integrated compressed air pipe						
Available energy supply						
	Page					
Festoon System	11					
Cable Chain	12					
Tapping Valve System	13					





# Series C40

## Galvanized Steel C Rail

- **Reliable guiding** provided by robust steel slide carriers
- **Simple installation** using variable brackets
- **Compact installation space** due to small cross section



The classical Conductix-Wampfler C rail series is galvanized and available in lengths up to six meters. They can be combined into rail lines of any length.

Energy can be supplied either through a festoon system or by attaching a cable chain.

### 1:2 Cross Section

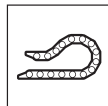
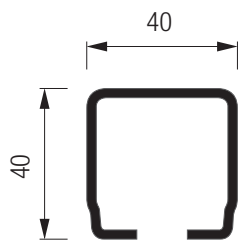

### Standard Application Data

Weight	Per meter	2.55 kg/m
Profile length		Max. 6 m
Load capacity	Point load	Max. 125 kg*
Suspension distance		Max. 2.2 m
Carriage		Steel carriage, inside running

- Main applications**
- Installation workplaces
  - Workbenches
  - Jib boom equipment
  - Equipment cranes

\* For higher load requirements, please contact factory.







# Series C75 Aluminum Profile

- **High stability** provided by optimum cross section aluminum profile
- **Easy and quick installation**
- **Simple carriage after profile installation** without downtime
- **Smooth-running ball bearings** with plastic bandage
- **4 additional grooves** allows quick, easy attachment of accessories
- **Easy to clean** rails and carriages due to externally mounted profile
- **Corrosion-resistant**

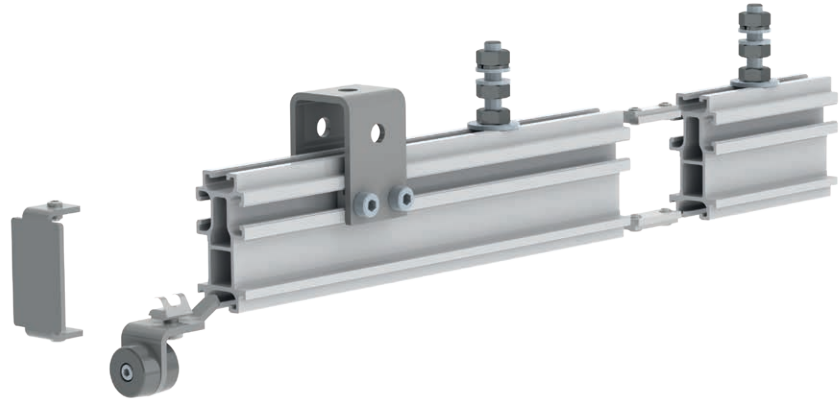

Conductix-Wampfler aluminum profiles are galvanized and available in lengths up to six meters. They can be combined into rail lines of any length.

## 1:2 Cross Section

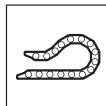
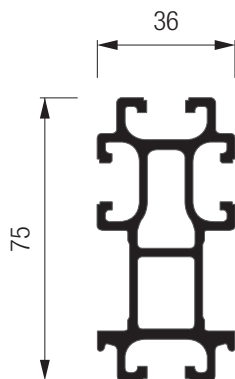

## Standard Application Data

Weight	Per meter	1.82 kg/m
Profile length		Max. 6 m
Load capacity	Point load	Max. 80 kg
Suspension distance		Max. 3.2 m
Carriage	Steel carriage, ball bearings with plastic bandages, outside running	

**Main applications**

- Installation workplaces
- Workbenches





# Series A62

## Aluminum Profile with Integrated Compressed Air Pipe

- **High air flow rate with minimum loss of pressure**, using integrated 2" compressed air pipe
- **Quick, easy installation**
- **Quiet, low-wear movement** with excellent rolling characteristics
- **Additional simple carriage installation** without downtime
- **Complete coverage of work area** with compressed air through integrated outlets
- **Corrosion-resistant**

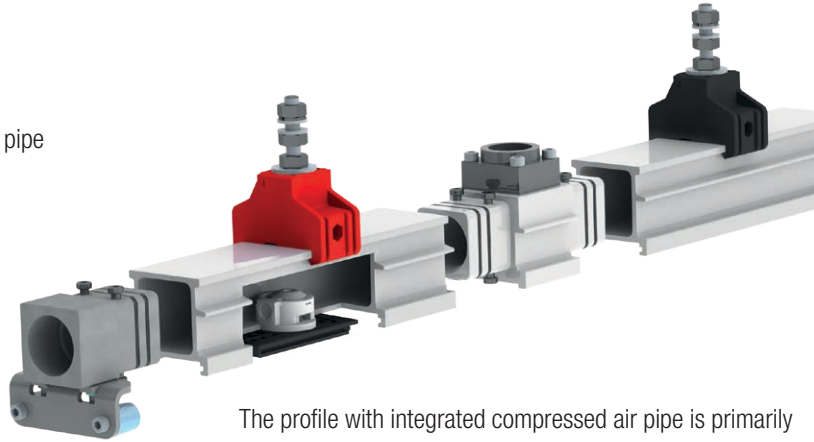

The profile with integrated compressed air pipe is primarily suited for tapping valves with tapping carriages, but also for cable chains. It is therefore available with or without tapping valves. Standard A62 profiles have tapping valves embedded every 1.5 m. The profiles are sealed with silicone-free, oil-resistant O-rings. Maximum sealing and corrosion resistance are guaranteed.

### 1:2 Cross Section

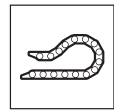
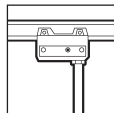
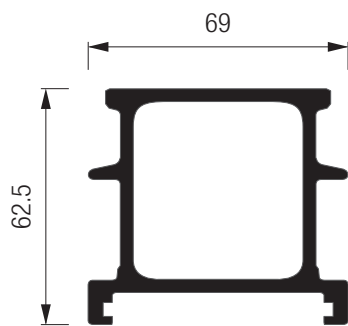

### Standard Application Data

Weight	Per meter	2.63 kg/m
Profile length		Max. 6 m
Load capacity	Point load	Max. 120 kg
Suspension distance		Max. 3.4 m
Cross section compressed air tank		(~2" pipe)   2098 mm <sup>2</sup>
Working pressure		Max. 10 bar
Carriage		Aluminum / plastic with steel rollers, outside running

**Main applications**

- Installation workplaces
- Long assembly lines
- Highly automated production lines







# Series W<sup>5</sup>-traxX

## Aluminum Profile with Integrated Compressed Air Pipe

- **High load capacity at very low component weight** provided by cross-section-optimized special aluminum profile
- **Optimal compressed air supply, even with many powered devices**, using integrated 2" compressed air pipe
- **Maximum flexibility**, compressed air outlets can be positioned freely
- **Flexible and adaptable**; terminal profiling on all sides
- **Safe, low-friction guiding** due to I-profile trolleys with polyamide flange rollers
- **Corrosion-resistant**

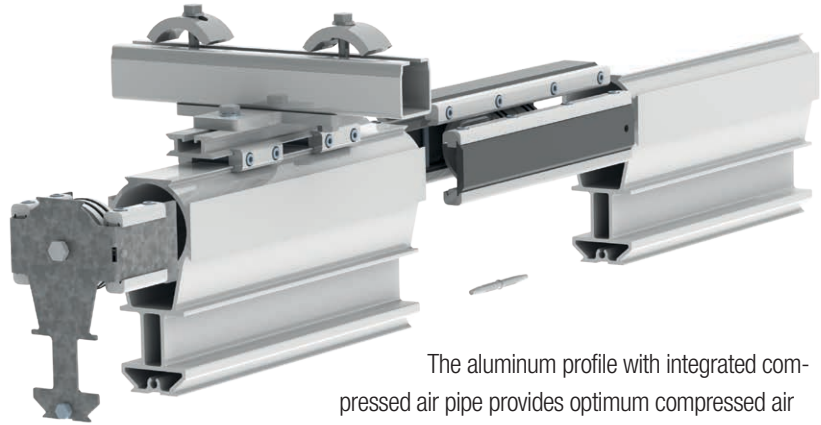

The aluminum profile with integrated compressed air pipe provides optimum compressed air supply even for many tools that have with high air requirements. The special profile with optimized cross section allows a high load capacity with very low intrinsic weight and its arbitrarily located compressed air outlets permit maximum flexibility. As a standard, we offer profiles with compressed air outlets every 2 m.

### 1:2 Cross Section

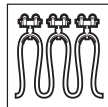
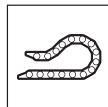
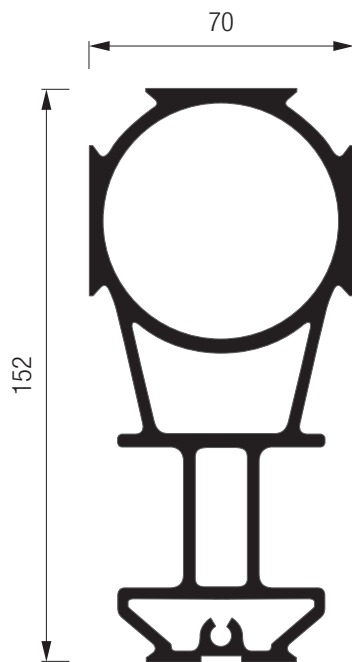

### Standard Application Data

Weight	Per meter	5.4 kg/m
Profile length		Max. 6 m
Load capacity	Point load	Max. 100 kg
Suspension distance		Max. 4 m
Cross section compressed air pipe	(>2" pipe)	3116 mm <sup>2</sup>
Working pressure		Max. 12 bar
Carriage		Steel carriage with polyamide rollers, outside running

**Main applications**

- Installation workplaces
- Long assembly lines
- Highly automated production lines





FT 350.0315 CE



# Series A180

## Aluminum Profile with Integrated Compressed Air Pipe

- Aluminum profile with optimized cross section **permits reduced steel structure** (Finite Element Method-optimized)
- **Quiet, low-wear movement** with excellent rolling characteristics
- **Simple integration of peripheral elements**, 6 grooves for fastening
- **Additional simple carriage installation** without downtime
- **Corrosion-resistant**
- **Complete coverage of work area with compressed air** through integrated compressed air outlets

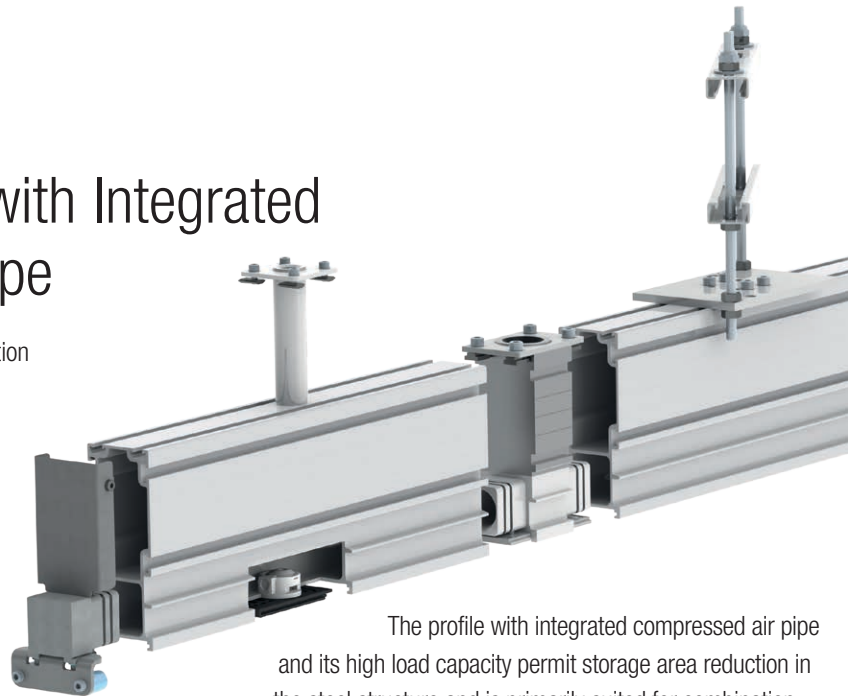

The profile with integrated compressed air pipe and its high load capacity permit storage area reduction in the steel structure and is primarily suited for combination with tapping valves with tapping carriages, but also for cable chains. It is therefore available with or without tapping valves. Standard A62 profiles have tapping valves embedded every 1.5 m. Grooves on three sides permit the attachment of peripherals. The A62 and A180 profiles are compatible.

### 1:2 Cross Section

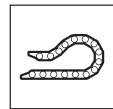
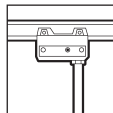
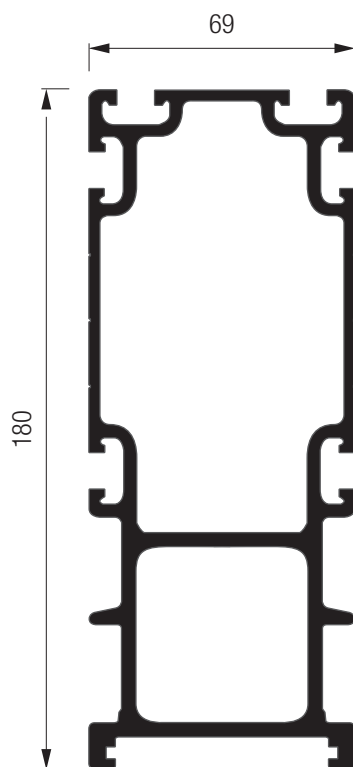

### Standard Application Data

Weight	Per meter	5.7 kg/m
Profile length		Max. 6 m
Load capacity	Point load	Max. 120 kg
Suspension distance		Max. 6 m
Cross section compressed air pipe	(~2" pipe)	2098 mm <sup>2</sup>
Working pressure		Max. 10 bar
Carriage	Aluminum / plastic with steel rollers, outside running	



**Main applications**

- Assembly workplaces
- Long assembly lines
- Highly automated production lines



# Media Supply

Three different types of media supply in combination permit the right solution for any customer application case. The matrix below compares their technical characteristics and the associated application possibilities.

	Festoon System	Cable Chain	Tapping Valve
			
Page	17	18	19
<b>Advantages / characteristics</b>			
No spring force		✓	✓
No line loops		✓	✓
Full utilization of the work area		✓	✓
Continuous compressed air supply	✓	✓	
Electrical power supply possible	✓	✓	✓
Maintenance and disassembly without loss of pressure			✓
No restriction on cycle length			✓
Pressure loss factor *	3	1	2
Installation time factor *	3	2	1

\* 1 = very low | 2 = average | 3 = significant



# Festoon System

The simplest solution for the supply of compressed air and power, as well as for the use of data cables. Continuous media supply within the work area. Festoon systems can be implemented with any type of profile. With the A62, W<sup>5</sup>, and A180 profiles the compressed air can be taken directly from the rail.

We recommend only limited use of spiral hoses, because they:

- Apply spring forces to the user and therefore do not permit ideal ergonomics
- Cause greater pressure loss
- Are costly to purchase and maintain



- **Flexible movement** with simple transport system
- **Gentle guiding of hoses and lines** using flexible, multi-level, hanging line holders
- **Simple maintenance and upgrades**



## Standard Application Data

System length	Compressed air	Max .25 m
	Electrical	Max. 25 m
Capacity	Compressed air	Up to 3 hoses 1/2"
	Cables	Up to 10 x round/flat cable
Working pressure	Max.12 bar	
Interface	Supply using preassembled interface and couplings	
Operating conditions	Interior use; +10°C to 60°C	

# Cable Chain

Ideal solution for the continuous supply of compressed air and power, as well as the use of data lines, for example for the collection of data about screw connections.

In contrast with the tapping valve solution, compressed air is continuously supplied.



- Suitable for **stationary** and **continuous workstations**
- **Minimal pressure loss** due to midcycle feed
- **No cable loops**
- **Use of complete system length** by eliminating the hose station
- **Minimum force needed to move carrier** with easy-moving rollers

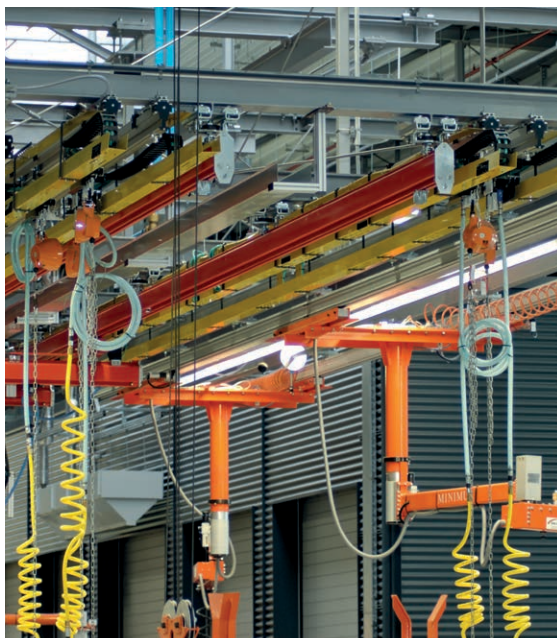

## Standard Application Data

System length	Cycle length	18 m
Capacity	Compressed air	2 DN13 hoses
	Power	Up to 4 cables 5 x 2.5 mm <sup>2</sup>
Working pressure		Max. 12 bar
Interface	Supply through terminal box/ preassembled interfaces	
Operating conditions	Interior use; +10°C to 60°C	



# Tapping Valve

By default the A62 and A180 have tapping valves spaced at 1.5 m. Other spacing is available as an alternative. The tapping carriages automatically dock when they pass over the tapping valves and supply the tools with compressed air.

The carrier can be disconnected at any time by pulling on the hose or with a detaching device, and moved to the next docking point. Both mechanical and pneumatic detaching devices are available.

The tapping valve allows work along the entire length of the rail profile.

This feature is not available from any other media supply system!



- Suitable for **stationary** and **continuous workstations**
- **Higher air flow rate** with minimal pressure loss
- **No cable loops**
- **Use of complete system length** by eliminating the hose station
- **Unlimited number of tapping carriages** in a single work cycle
- **Simple addition** of additional workstations
- **Minimum force needed to move carrier** with easy-moving rollers

## Standard Application Data

System length	Cycle length	Unlimited
Capacity	Compressed air	Max. 1/2"
Working pressure		Max. 10 bar
Interface	Supply using preassembled interface and couplings	
Operating conditions	Interior use; +10°C to 60°C	







# Complete Solutions

**Equipment carriers** are mobile distribution stations for the energy fed through the media supply system.

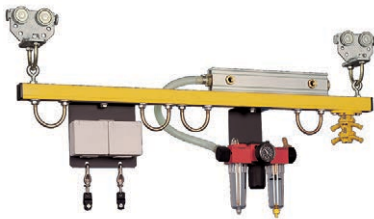

## Air treatment

Individual air preparation on-site ensures consistently high performance and a long service life for the tools and devices supplied.

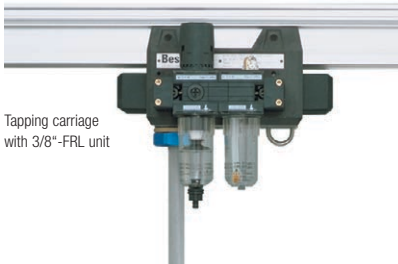

Tapping carriage with 3/8" -FRL unit

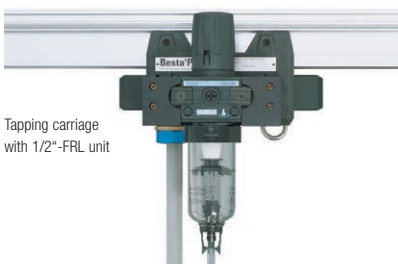

Tapping carriage with 1/2" -FRL unit

**Customer-specific solutions** are top priority at Conductix-Wampfler. We calculate, plan, and fabricate your entirely custom, ergonomically optimized tool carriers, including all needed accessory elements and equipment.

For individual layout of equipment carriers, Conductix-Wampfler offers a wide variety of **accessories**:

- Compressed air connectors
- Filter regulator-lubricator
- Electrical connections/distributors
- Cable/hose reels
- Balancers/retractors
- Pegboards
- Warehouse storage bins
- Tool Quivers
- Light fixtures
- And many more

**Light-weight, but rugged suspension** permits significant reduction in steel structure requirements.

## Tool transporter

Pull-out lengths of 1750 mm through 3150 mm (optionally adjustable) and rotating variants ( $\pm 180^\circ$ ) allow countless variations in installed equipment.

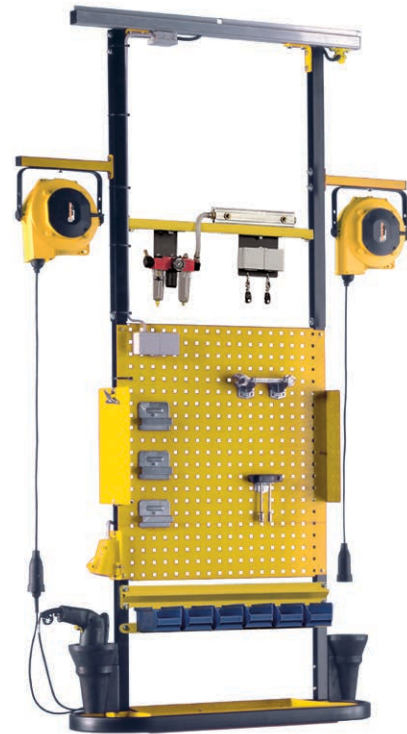



# Custom-fit Service

## Industry-specific competence

The scope and depth of Conductix-Wampfler's services are oriented toward the specific requirements of our customers. Services may include: layout and planning, installation and commissioning, and full service contracts. The more complex the system design / operational expectations, the more important it is to make use of our experienced service team. We're ready for your challenge!

## Project planning

- Product-neutral consulting
- Selection of the best compressed air and electric supply system optimized for customer requirements, parameters of use, and environmental influences
- Creation of layouts based on customer specifications

## Installation and commissioning

- Delivery of preassembled systems
- On-site supervision and inspection available
- Adhering to customer's quality assurance guidelines
- Complete installation and commissioning by trained, experienced technical staff



## Service and maintenance

- Regular preventative maintenance and inspections increase the life of your system and ensure many years of use
- Conductix-Wampfler service agreements: the "complete worry-free package"



From project planning and preassembly to on-site installation, Conductix-Wampfler specialists are there for our customers - anywhere in the world!





# Other Products from Conductix-Wampfler

The products described in this catalog represent a few of the products from the broad spectrum of Conductix-Wampfler components and systems for the transfer of energy, data, gases, and fluids. The solutions we deliver for your applications are based on your specific requirements. In many cases, a combination of several different Conductix-Wampfler products are needed to fill the application. You can count on all of Conductix-Wampfler's business units for hands-on engineering support - coupled with the perfect solution to meet your energy management and control needs.



### Motor driven cable reels

Motor driven reels by Conductix-Wampfler are the perfect solution for managing long lengths of heavy cable and hoses in very demanding industrial applications. Monospiral, level wind, and random wind spools.

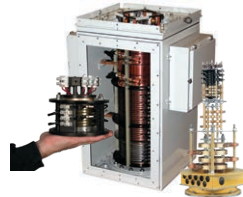

### Slip ring assemblies

Whenever powered machinery needs to rotate 360°, field proven slip ring assemblies by Conductix-Wampfler can flawlessly transfer energy and data. Here, everything revolves around flexibility and reliability.



### Conductor bar

Whether they are enclosed conductor rails, expandable single-pole bar systems, or high amperage bar for demanding steel mill use up to 6000 amps. Conductix-Wampfler's conductor bar is the proven solution to reliably move people and material.



### Spring driven cable reels

We have 60 years experience and trusted brands such as Insul-8, Wampfler, and IER. We offer small cord reels all the way to large multi-motor units, a wide range of accessories, and hazardous location reels.



### Cable Festoon systems

It's hard to imagine Conductix-Wampfler cable trolleys not being used in virtually every industrial application. They are reliable and robust and available in an enormous variety of sizes and models.



### Push Button Pendants

Our ergonomic pendants are ideally suited for industrial control applications. They are available in a wide range of configurations for overhead cranes and other machinery.



### Radio remote controls

Safe, secure, and reliable radios use the latest in microprocessor technology. Available in several models for overhead crane control and other types of machinery.



### Inductive Power Transfer IPT®

The contact-less system for transferring energy and data. For all tasks that depend on high speeds and absolute resistance to wear.



### Energy guiding chains

The "Jack of all Trades" when it comes to managing energy and data cables and air and fluid hoses. A wide range of energy guiding chains are available for many industrial applications.



### Air hoists and balancers

ENDO Air hoists accurately place delicate loads and continuously vary the speed for precise positioning. They run cool in continuous operations.



### Bumpers

Conductix-Wampfler offers a complete range of bumpers for the auto industry, cranes, and heavy machinery. These include rubber, rubber/metal, and cellular types.



### Spring balancers and retractors

ENDO spring balancers by Conductix-Wampfler are rugged, reliable high-precision positioning devices that reduce operator fatigue and assist with accurate tool placement.

# www.conductix.us

## USA / LATIN AMERICA

10102 F Street  
Omaha, NE 68127

Customer Support  
Phone +1-800-521-4888

Phone +1-402-339-9300  
Fax +1-402-339-9627

info.us@conductix.com  
latinamerica@conductix.com

## CANADA

1435 Norjohn Court  
Unit 5  
Burlington, ON L7L 0E6

Customer Support  
Phone +1-800-667-2487

Phone +1-450-565-9900  
Fax +1-450-951-8591

info.ca@conductix.com

## MÉXICO

Calle Treviño 983-C  
Zona Centro  
Apodaca, NL México 66600

Customer Support  
Phone (+52 81) 1090 9519  
(+52 81) 1090 9025  
(+52 81) 1090 9013

Fax (+52 81) 1090 9014

info.mx@conductix.com

## BRAZIL

Rua Luiz Pionti, 110  
Vila Progresso  
Itu, São Paulo, Brasil  
CEP: 13313-534

Customer Support  
Phone (+55 11) 4813 7330

Fax (+55 11) 4813 7357

info.br@conductix.com

Contact us for our Global Sales Offices

